

MDP
Utilitaire



CADDY

2021

KIT SANS PLANCHER

Côtés - Passage de Roues

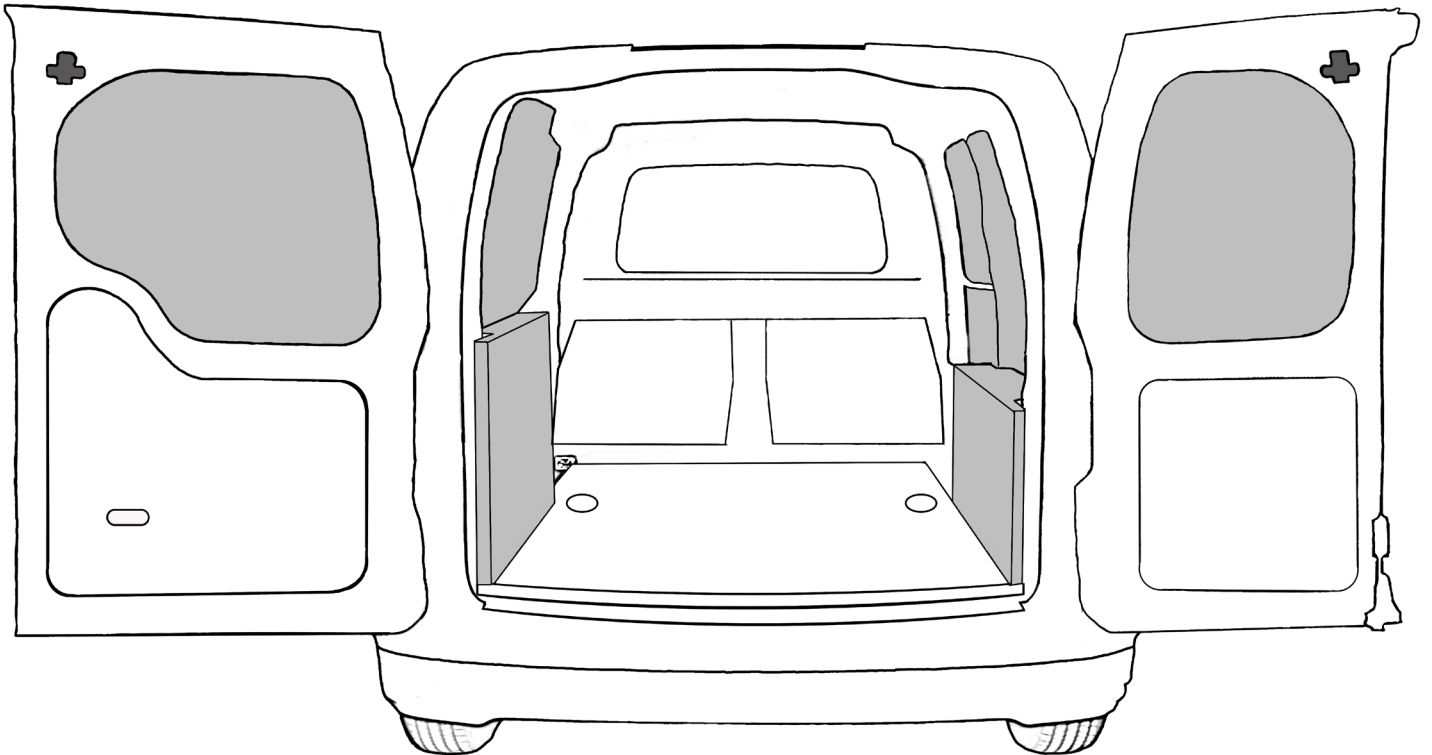

0h 45min



FRA Instructions de montage
CZA Pokyny pro montáž
DAN Monteringsveiledning
DEU Einbauanleitung
ENG Installation instructions
ESP Instrucciones de montaje
EST Paigaldusjuhised
FIN Aseennusohje
GRK Οδηγίες συναρμολόγησης
CRO Návody k montáži
HUN Beépítési utasítások
ITA Istruzioni per il montaggio
JPN 取付説明書

KOR 조립설명서
LTH Montavimo instrukcija
LET Montāžas instrukcijas
NLD Inbouwhandleiding
NOR Monteringsveiledning
PLK Instrukcje wbudowania
PTG Instruções de montagem
ROM Instrucțiuni de montaj
RUS Инструкция по монтажу
SLK Návod na zabudovanie
SLV Navodila za inštalacijo
SWE Montageanvisning
TRK Montaj talimatları



**Instructions
générales
de montage**

CÔTÉS ET PORTE LATÉRALE

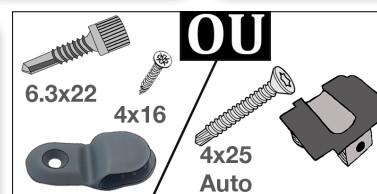
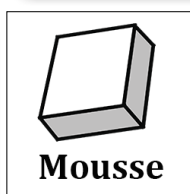
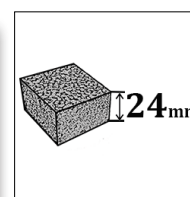
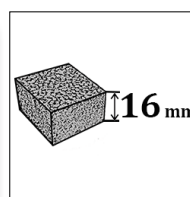
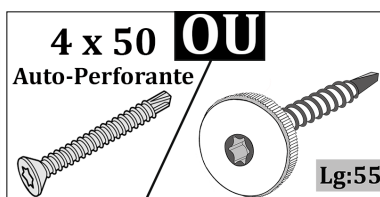
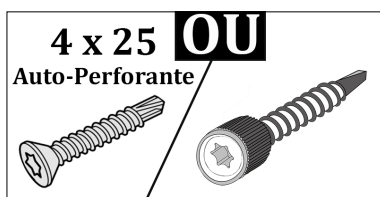
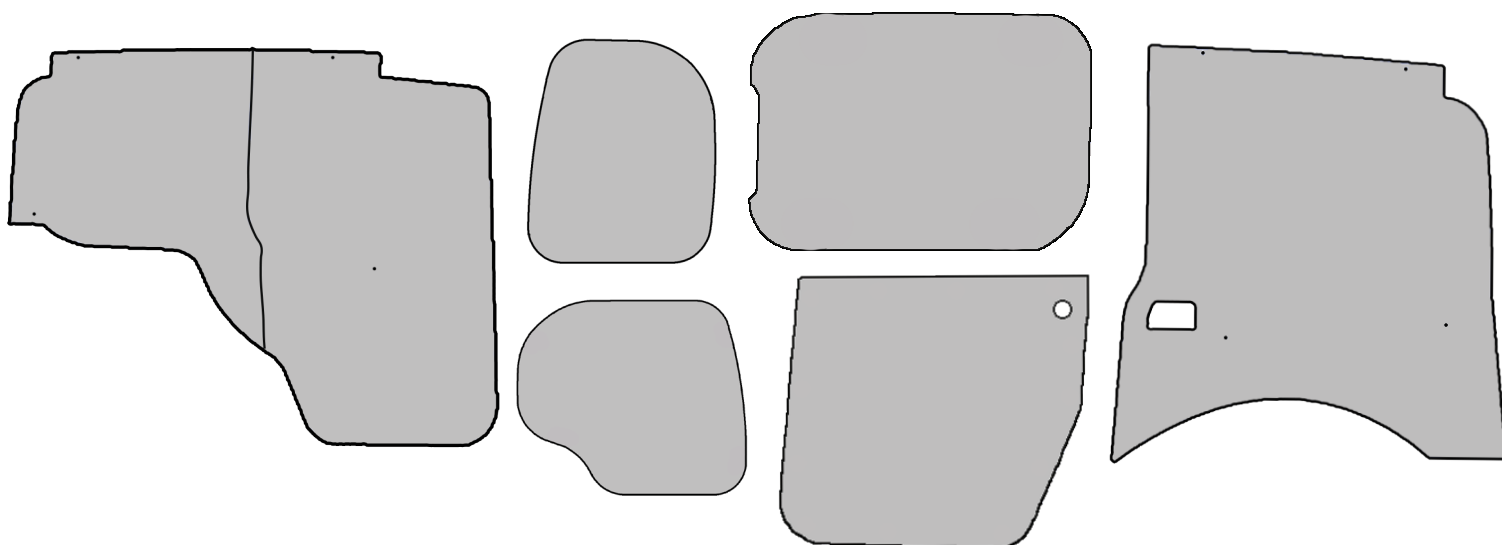
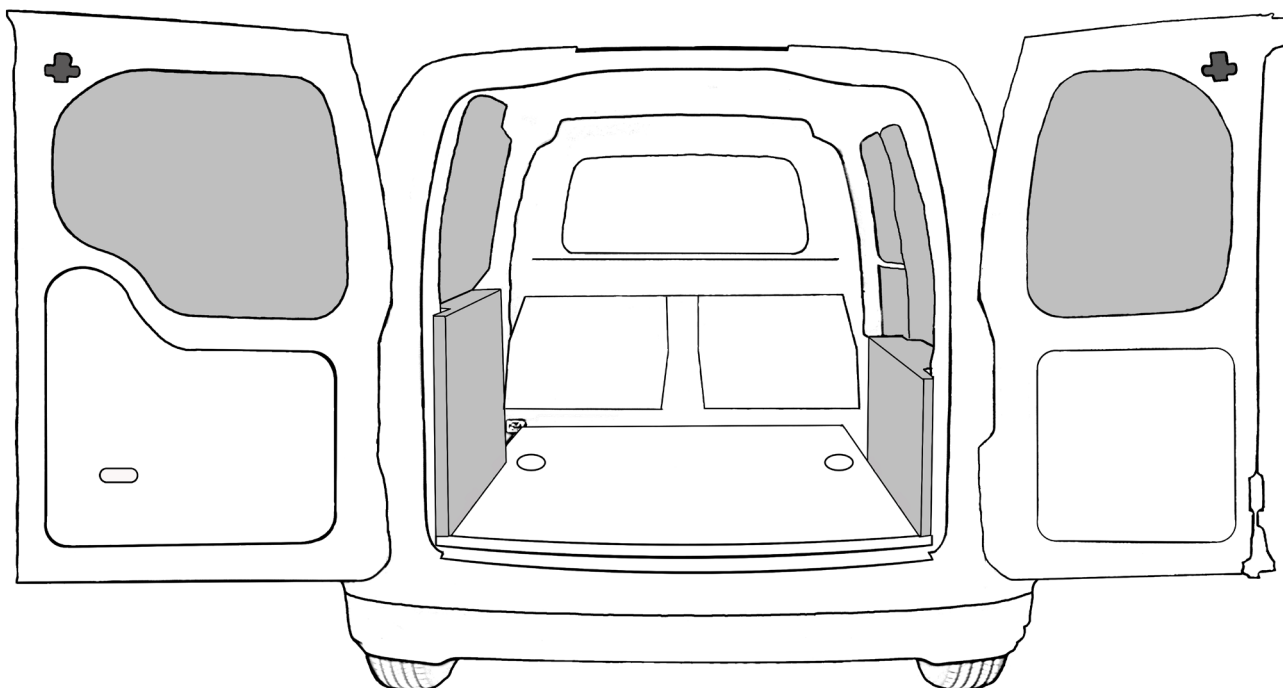

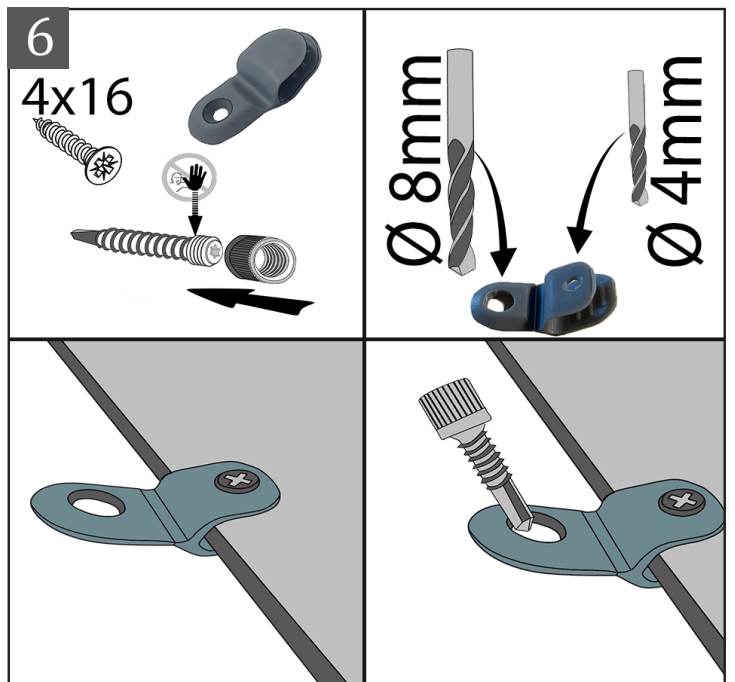
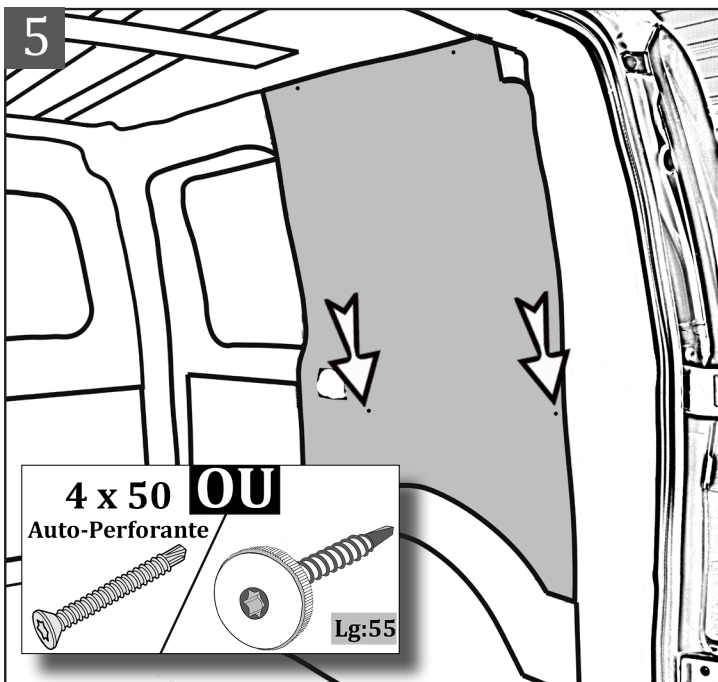
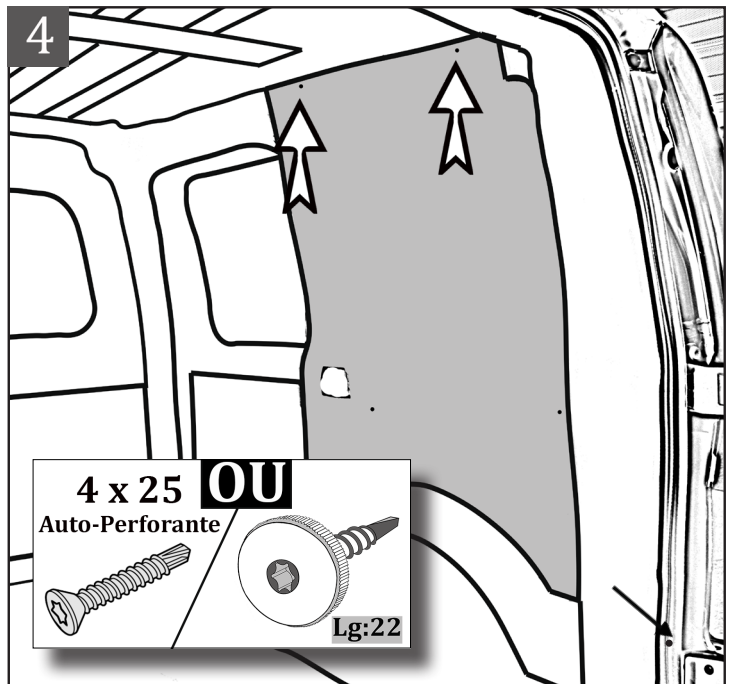
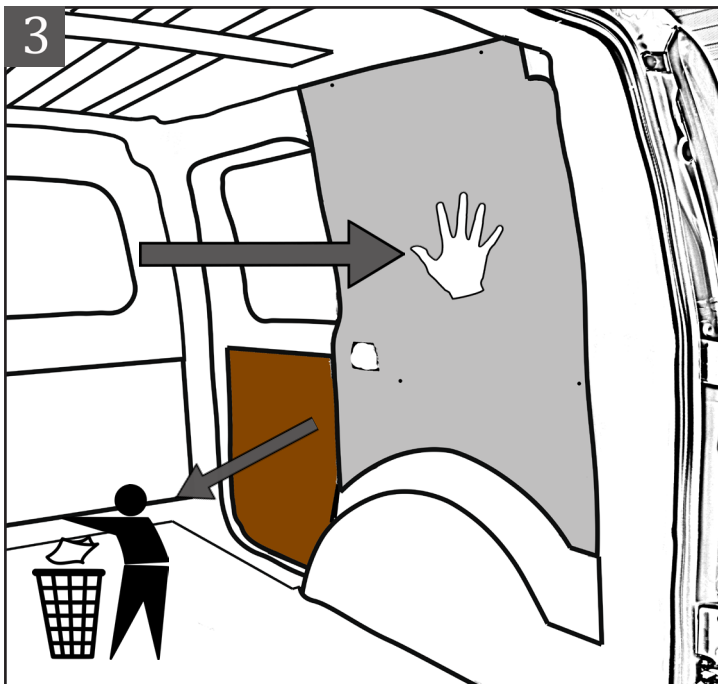
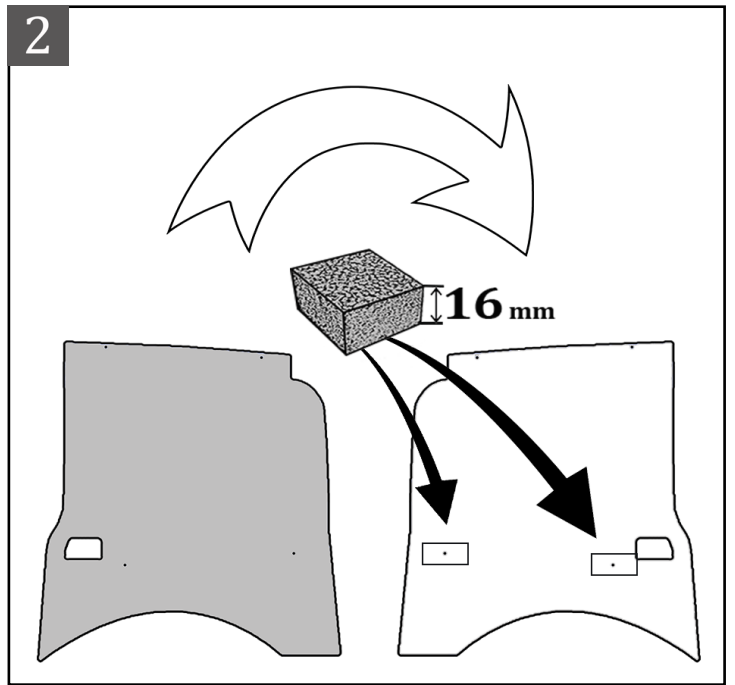
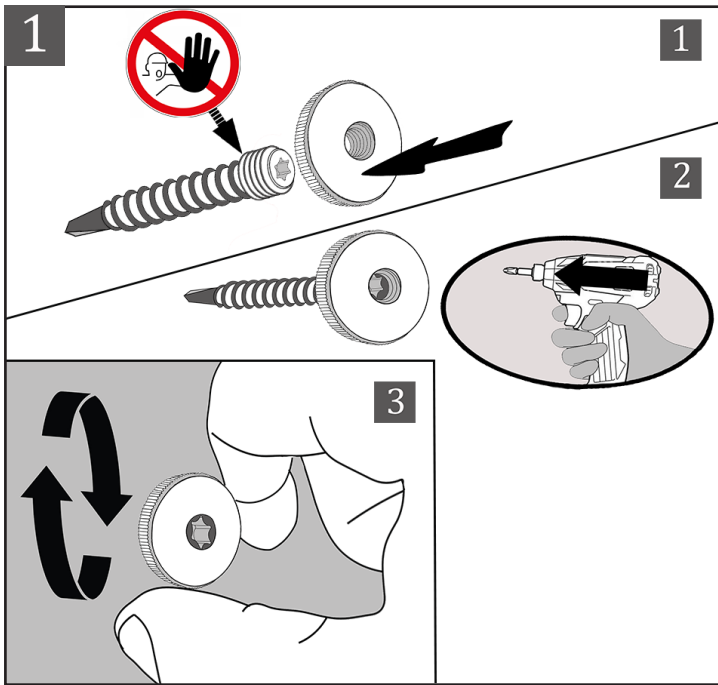

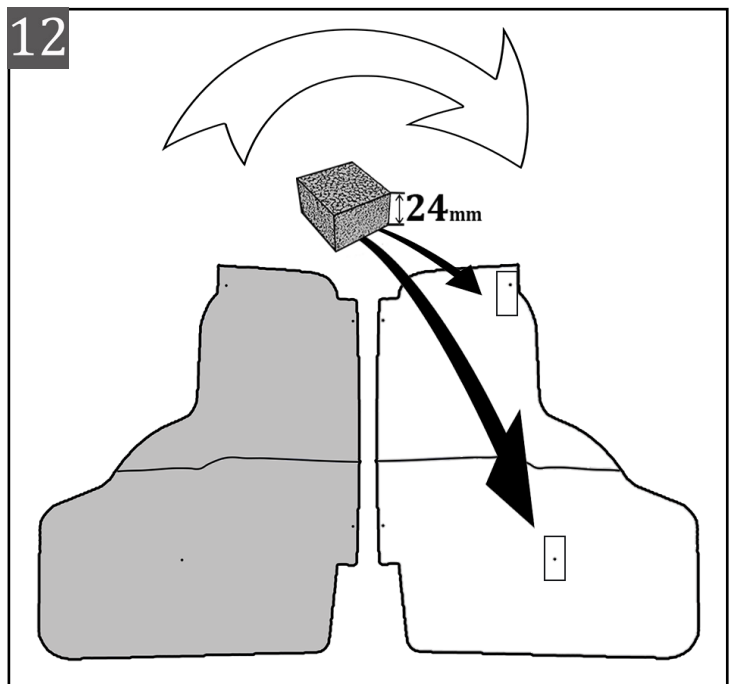
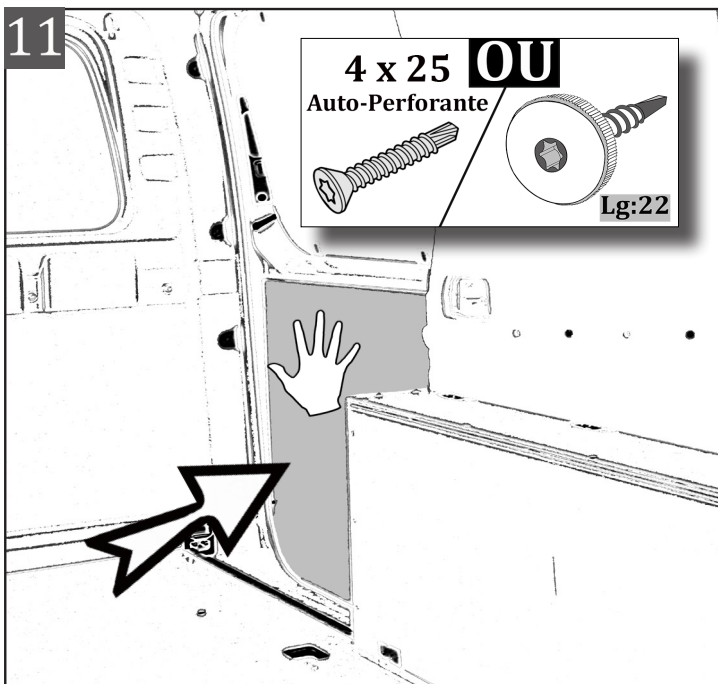
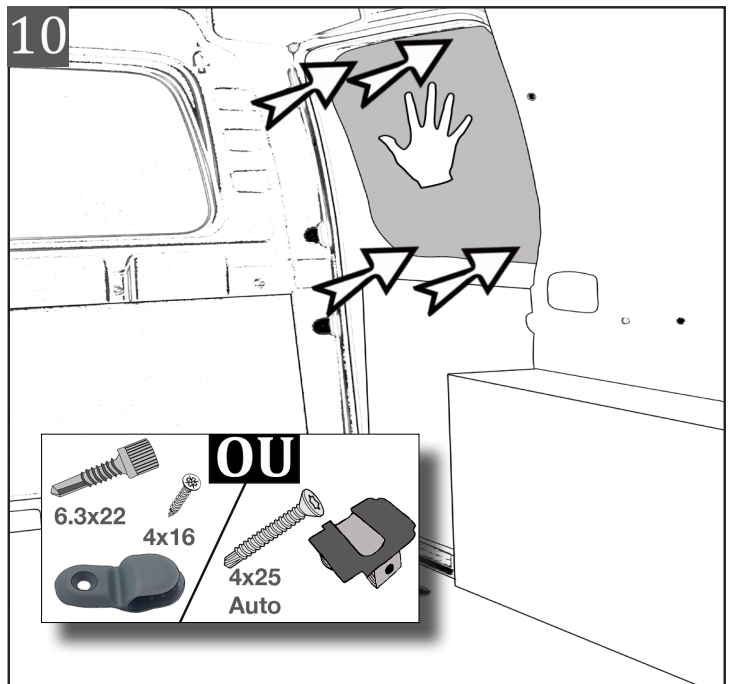
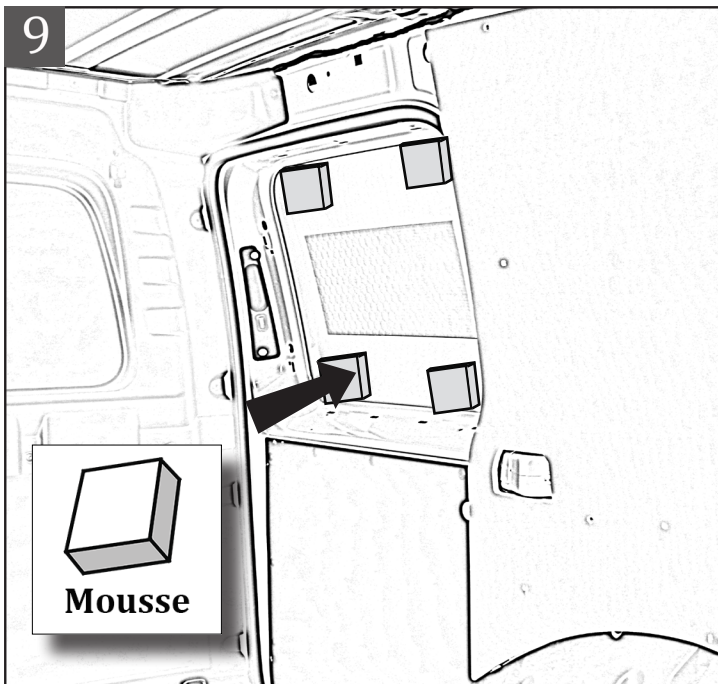
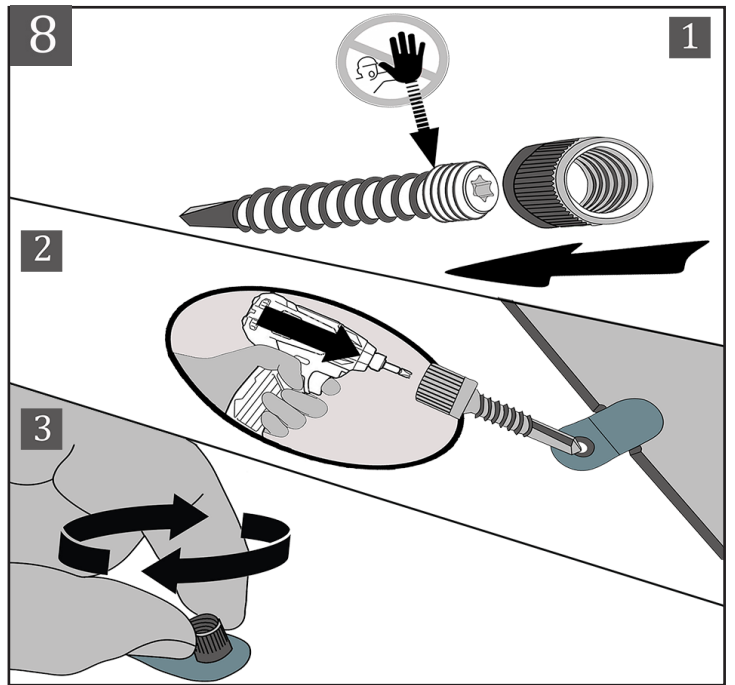
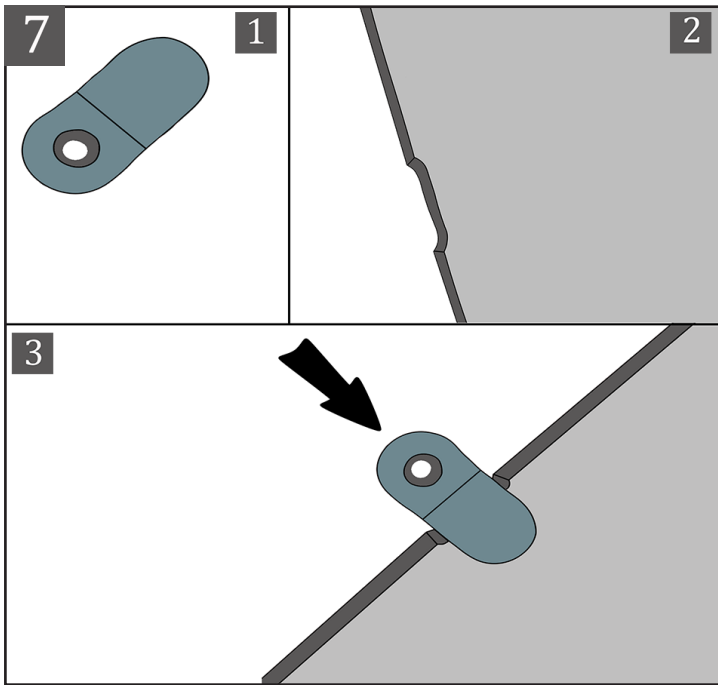

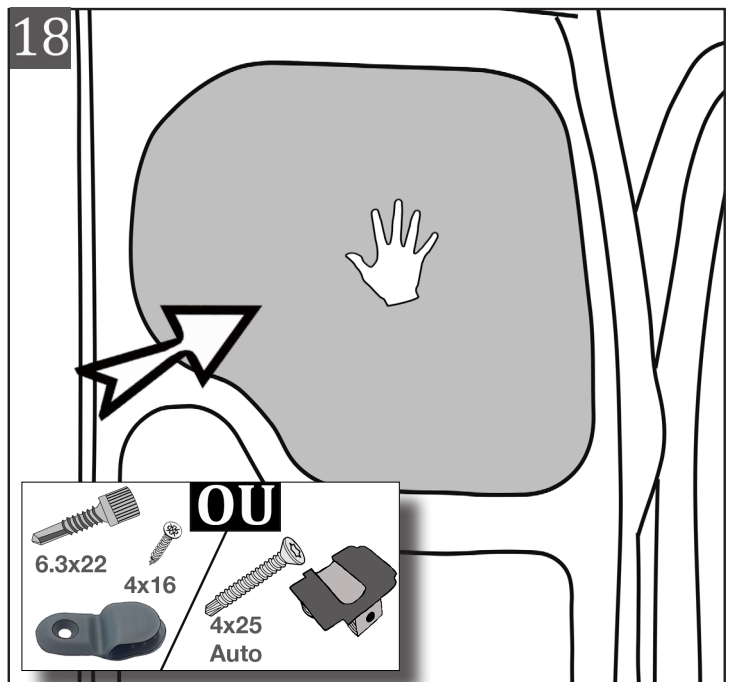
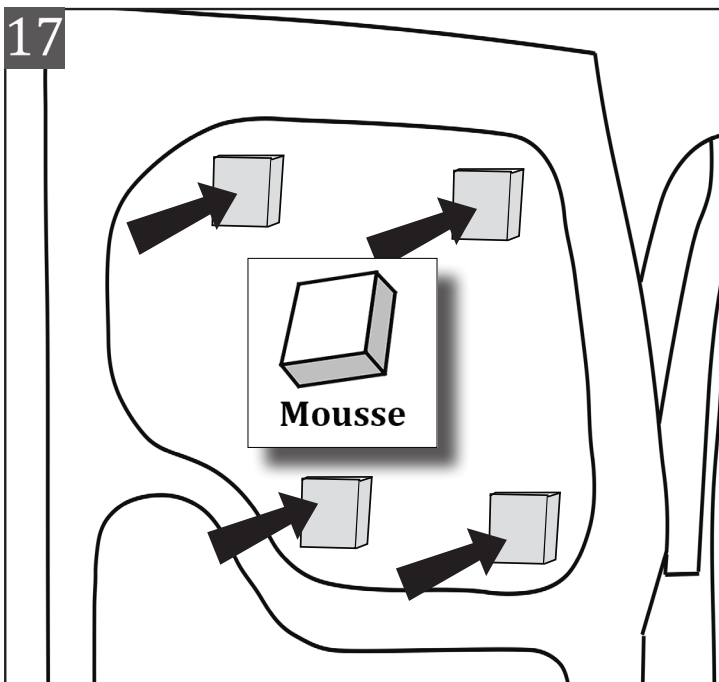
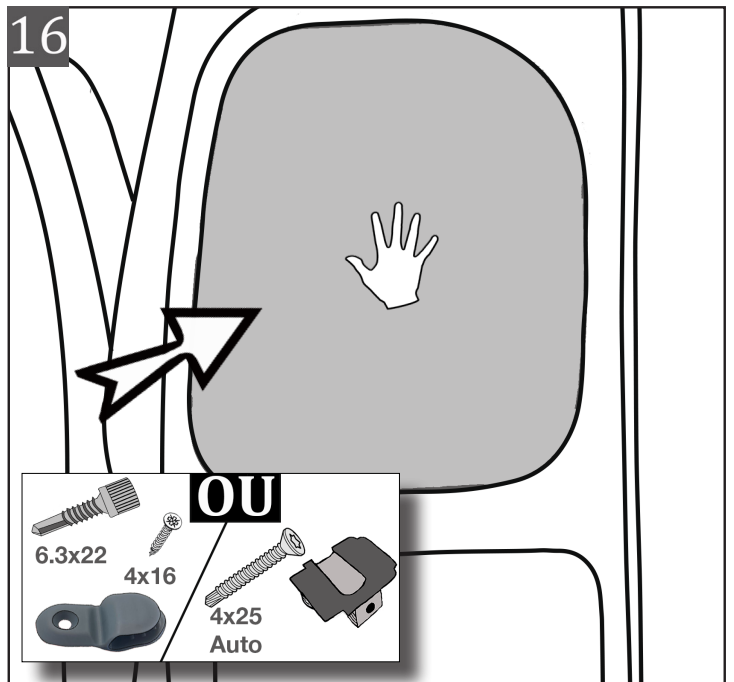
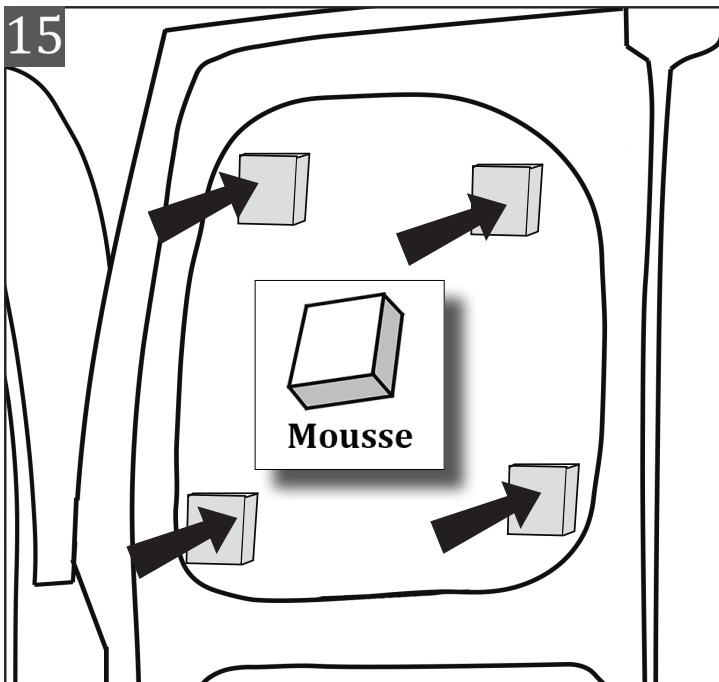
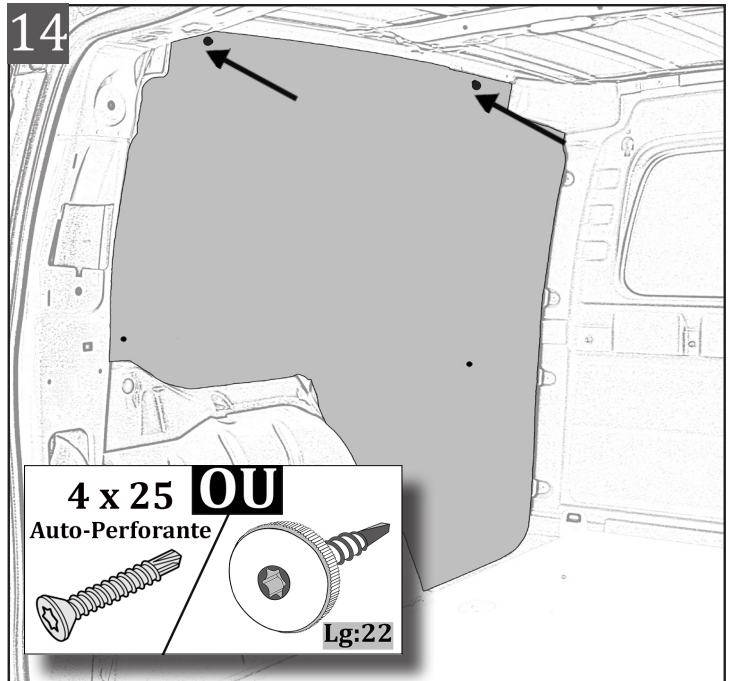
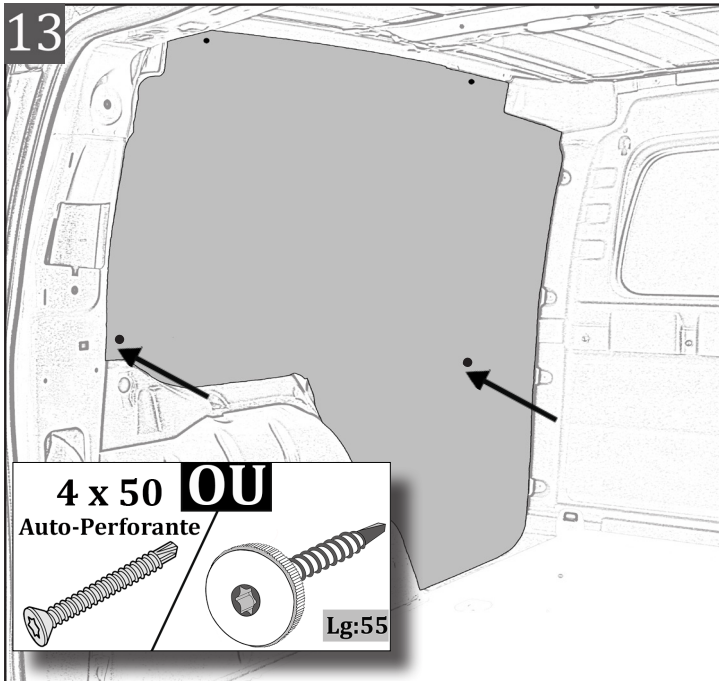

PASSAGES DE ROUES

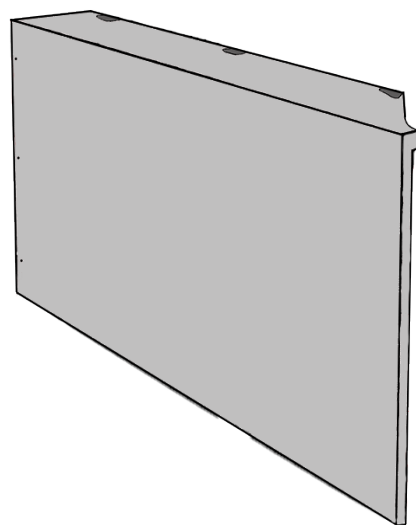
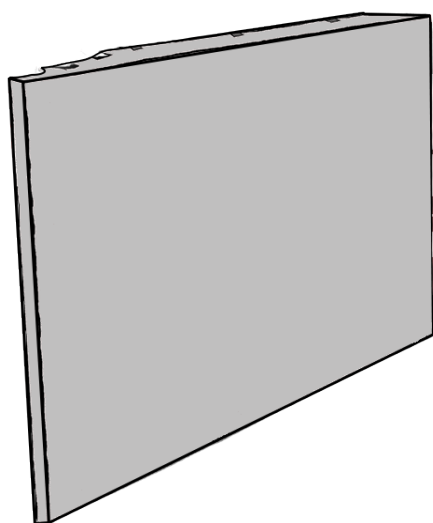
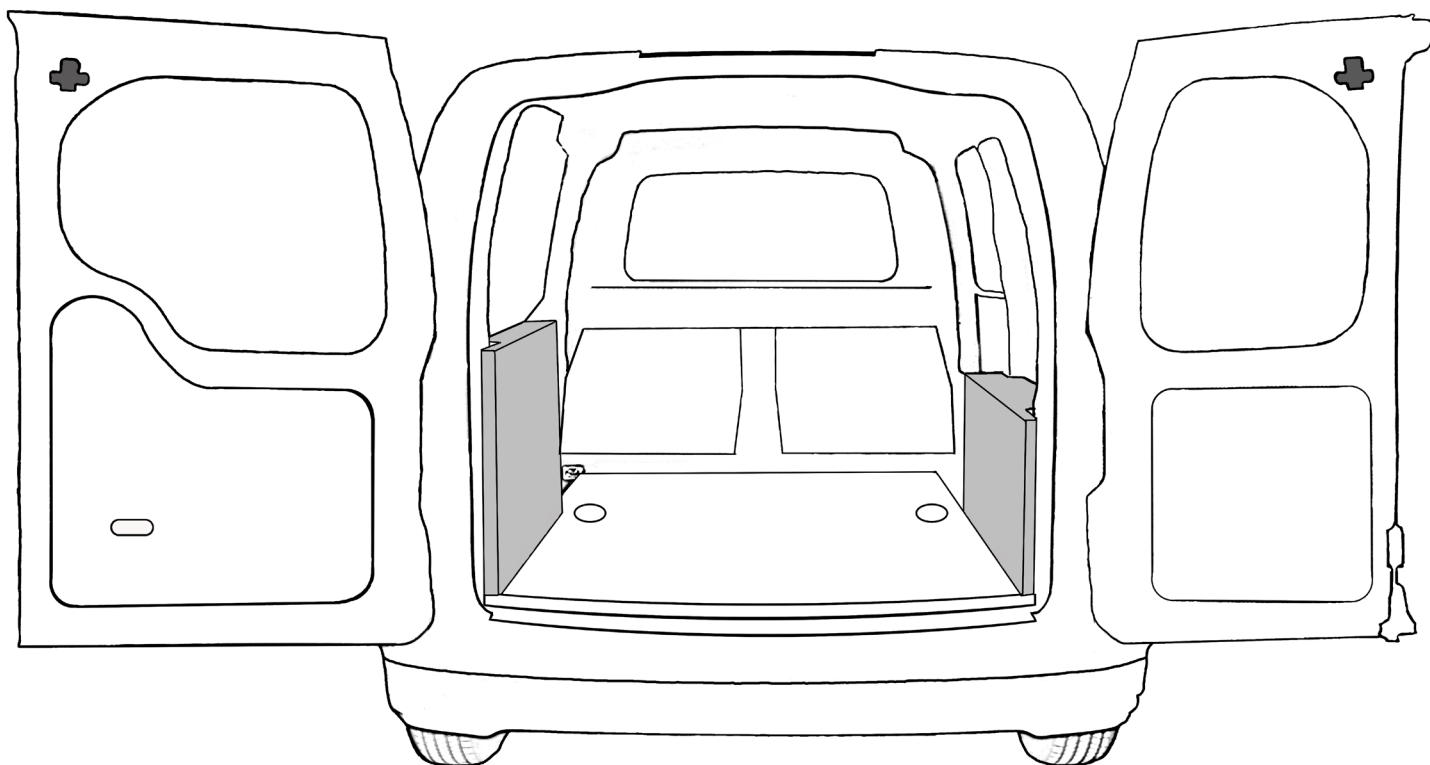

TORX 20

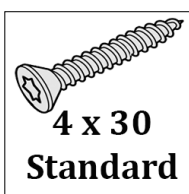

**4 x 30
Standard**

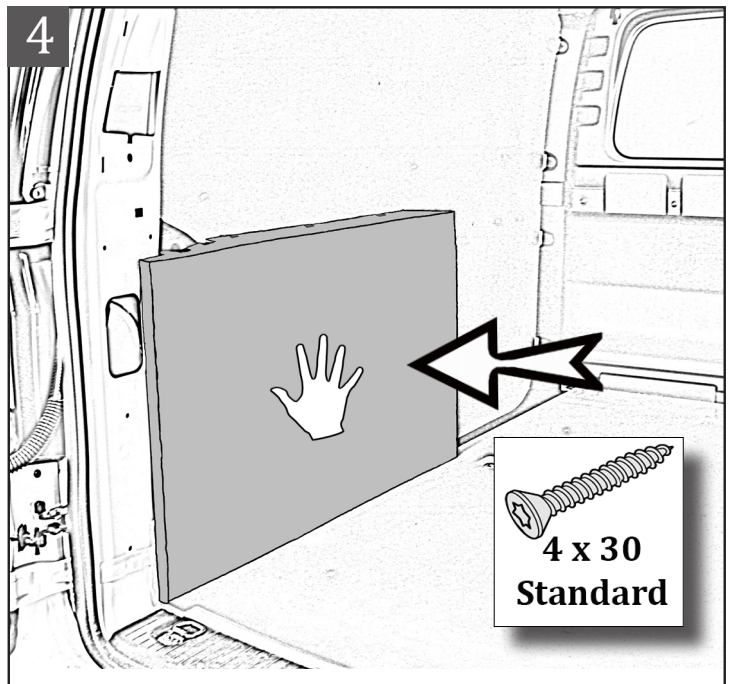
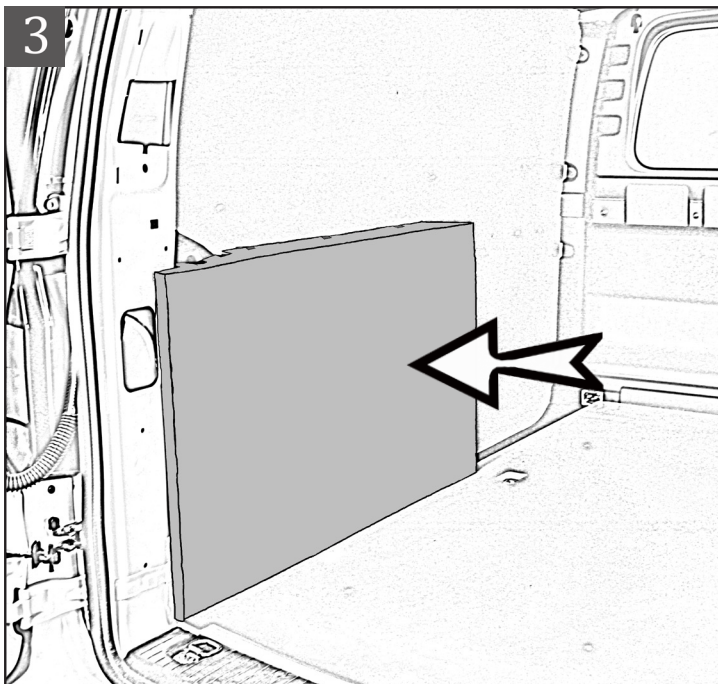
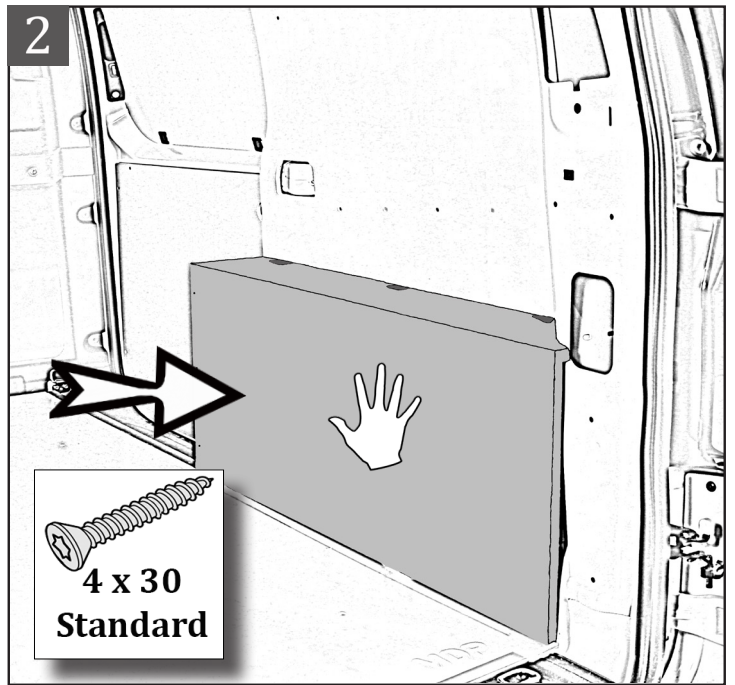
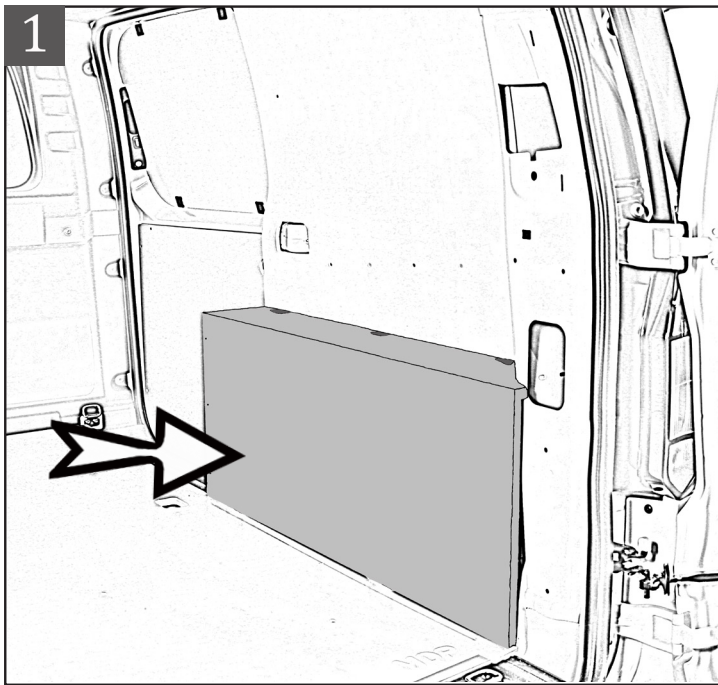

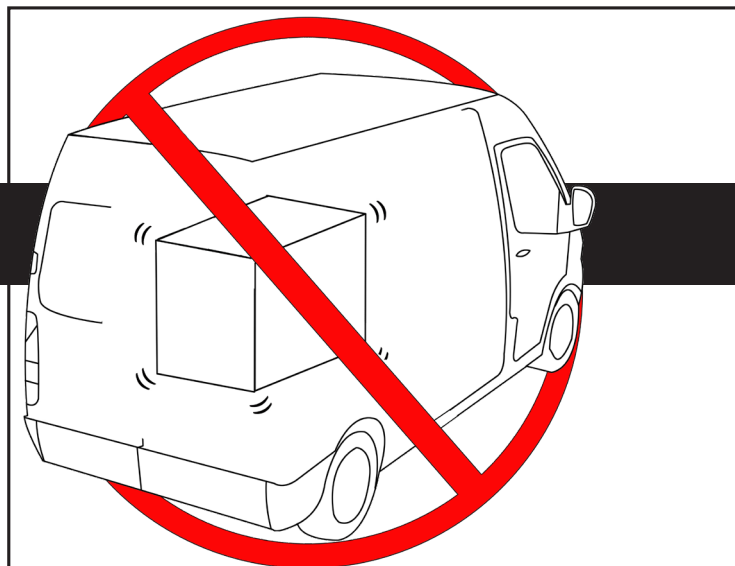
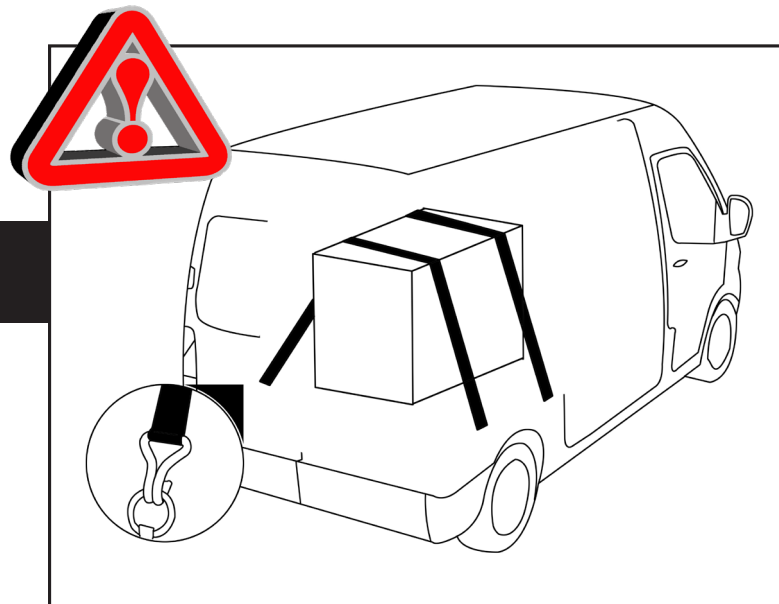

FRA

Les instructions de montage et/ou d'utilisation prescrites par le constructeur, dans ce présent document, sont établies en fonction des spécifications techniques en vigueur à la date d'établissement du document. Elles sont susceptibles de modifications en cas de changements apportés par le constructeur à la fabrication des différents organes et accessoires des véhicules de sa marque. Ce produit ne doit pas être utilisé sur d'autres véhicules que ceux spécifiés en haut de la première page de la notice de montage et/ou d'utilisation. La sécurité est garantie si la conformité aux instructions de montage et/ou d'utilisation est suivie. Le non respect de cette notice dégage toute responsabilité du constructeur

ENG

The instructions for assembly and/or use provided by the manufacturer in this document reflect the technical specifications that were applicable at the time of writing. These instructions are subject to change if the manufacturer makes changes to the production of the subsystems and accessories used in the brand's vehicles. This product must only be used with the vehicles mentioned at the top of the first page of the assembly and/or user manual. Following the instructions for assembly and/or use will guarantee safe use of the product. The manufacturer shall not be held liable if these instructions are not followed.

DEU

Die Montage- bzw. Bedienungsanleitungen, die im vorliegenden Dokument vom Hersteller vorgeschrieben werden, basieren auf den zum Zeitpunkt der Erstellung gültigen technischen Spezifikationen. Sie unterliegen eventuellen Änderungen im Falle von Modifikationen seitens des Herstellers bei der Fertigung verschiedener Komponenten und des Zubehörs der Fahrzeuge seiner Marke. Dieses Produkt darf bei keinem anderen als dem oben auf der ersten Seite dieser Montage- oder Bedienungsanleitung angegebenen Fahrzeug verwendet werden. Die Sicherheit ist garantiert, insofern die Montage- oder Bedienungsanleitung befolgt wird. Bei Nichtbeachtung dieser Anleitung wird vom Hersteller keine Haftung übernommen.

ESP

Las instrucciones de montaje y/o de utilización prescritas por el constructor en este documento se han establecido en función de las especificaciones técnicas en vigor en la fecha de elaboración del documento. Estas instrucciones pueden ser modificadas en caso de que el constructor introduzca cambios en la fabricación de las diferentes unidades y accesorios de los vehículos de su marca. Este producto solamente se puede utilizar con los vehículos especificados en la parte superior de la primera página de las instrucciones de montaje y/o de utilización. La seguridad del producto está totalmente garantizada si se siguen todas las instrucciones de montaje y/o de utilización. Sin embargo, el hecho de no respetar estas instrucciones exime al constructor de toda responsabilidad.

ITA

Le istruzioni di montaggio e/o d'uso prescritte dal costruttore, nel presente documento, sono elaborate in funzione delle specificazioni tecniche in vigore alla data dell'elaborazione del documento. Sono suscettibili di modifiche qualora il costruttore apporti delle modifiche nella fabbricazione di differenti organi e accessori dei veicoli recanti il suo marchio. Questo prodotto non deve essere utilizzato su veicoli diversi da quelli specificati in alto nella prima pagina delle istruzioni di montaggio e/o d'uso. La sicurezza è garantita nel caso in cui viene osservata la conformità alle istruzioni di montaggio e/o d'uso. Il mancato rispetto di queste istruzioni declina il costruttore da ogni responsabilità.

PTG

As instruções de montagem e/ou utilização prescritas pelo construtor, no presente documento, são estabelecidas em função das especificações técnicas em vigor, à data da sua redacção. Estas instruções são susceptíveis de modificação, no caso de se verificarem alterações, introduzidas pelo construtor, no fabrico dos diferentes órgãos e acessórios das viaturas da sua marca. Este produto não deve ser utilizado em veículos diferentes dos especificados na parte superior da primeira página do juia de montagem e/ou de utilização. A segurança é garantida, se forem respeitadas as instruções de montagem e/ou utilização. O desrespeito por estas instruções iliba o construtor de qualquer responsabilidade.

NLD

De door constructeur voorgeschreven aanwijzingen voor de montage en/of het gebruik die in dit document staan, zijn opgesteld volgens de technische richtlijnen die van kracht waren toen dit document werd samengesteld. Deze kunnen veranderen indien de constructeur fabricagewijzigingen op onderdelen of accessoires van de auto's van zijn merk heeft aangebracht. Dit product mag alleen worden gebruikt op de modellen die zijn aangegeven bovenaan de eerste bladzijde van de montage en/of gebruiksaanwijzing. De veiligheid is alleen gegarandeerd als conform de montage en/of gebruiksaanwijzing is gewerkt. De constructeur is niet aansprakelijk indien deze aanwijzingen niet zijn opgevolgd.

SLV

Navodila za montažo in/ali uporabo, ki jih določa proizvajalec v tem dokumentu, so v skladu s tehničnimi specifikacijami, ki veljajo na dan sestave tega dokumenta. Te metode se lahko spremenijo v primeru, ko proizvajalec uvede spremembe pri izdelovanju različnih naprav in dodatne opreme na vozilih svoje znamke. Ta proizvod se sme uporabiti le na vozilih, ki so določena na vrhu prve strani navodil za montažo in/ali uporabo. Varnost je zagotovljena ob upoštevanju navodil za montažo in/ali uporabo. Proizvajalec ne prevzema nobene odgovornosti v primeru neupoštevanja teh navodil.

TRK

İşbu dokümanda, üretici tarafından öngörülen Onarım Metotları, dokümanın düzenlenme tarihinde yürürlükte olan teknik spesifikasyonlar doğrultusunda oluşturulmuştur. Bu metotlar, üretici tarafından araçların çeşitli organ gruplarının ve aksesuarlarının imalatında ve yapılabilecek modifikasyonlar doğrultusunda değiştirilebilir. Bu ürün, montaj ve/veya kullanım kitabının ilk sayfasının üst kısmında araçlar dışında kullanılmamalıdır. Montaj ve/veya kullanım talimatlarına uyuduğu sürece güvenlik garantisi altındadır. Bu kullanım kitabına uyulmaması halinde, üretici hiçbir şekilde sorumlu olmayacaktır.

SWE

De monterings- och/eller användningsanvisningar som tillverkaren föreskriver i detta dokument har upprättats i enlighet med de tekniska specifikationer som gällde vid dokumentets tillkomst. De kan ändras om tillverkaren av de olika delarna och tillbehören för respektive gör ändringar i produktionen. Denna produkt ska inte användas på andra bilar än dem som angivits högst upp på monterings- och/eller användningsanvisningarnas första sida. Säkerheten kan endast garanteras om monterings- och användningsanvisningarna följs. Om detta meddelande inte respekteras avsägar sig tillverkaren allt ansvar.